



CompactFlash USB Reader User's Manual

Model Name - IBM Compact-
Flash USB Reader (09N0692)
For use with Windows 98,
Windows 2000

Preface

Precautions

Accessories

Parts Identification

Quickstart Guide for windows

Installation with Windows

Connecting to a Computer

Basic Operations

Using with Windows 98/2000

Troubleshooting

Technical Support and Maintenance

Warranty Conditions



Preface

Thank you for purchasing **IBM licensed products from Apricorn**. The CompactFlash-USB card reader is designed to read and write to CompactFlash cards, when connected to Windows based computers with a USB port.

To get the most from your card reader, carefully read the instructions found in this manual before use.

Features:

The CompactFlash reader is equipped with a standard USB cable and connector for Universal Serial Bus, the most advanced and easy to configure PC interface for peripherals. The CompactFlash card reader has one slot designed for use with CompactFlash cards. The reader allows you to access data on CompactFlash cards generated by digital cameras and other digital devices utilizing CompactFlash memory cards.

CompactFlash cards are accessed through the card readers the same way as a floppy drive, or removable media drive. Using Windows the media is accessed using a drive letter. The CompactFlash reader enables the user to quickly download images to their computer without the need to connect the digital camera to the computer via serial port.

-
1. Changes may be made to this product or manual without notification.
 2. This manual may not be copied in part, or in whole without express permission.

While **Apricorn** aims to manufacture its readers to the highest standards, and make its readers compatible with the widest variety of PC cards, and computer systems possible, some incompatibilities may arise. Depending on your system configuration, PC card compatibility may vary. Please look to our web site at <http://www.apricorn.com/ibmflash> for FAQs for current information on compatibility issues.

MS-DOS and Microsoft Windows are trademarks of Microsoft Corporation.

IBM, the IBM logo and IBM trade dress are owned by International Business Machines and are used under license from IBM.

Table of Contents

Preface	2
Precautions	4
Accessories	7
Parts Identification	8
Installation Procedure	9
Installing the Device Driver	12
Connecting to a Computer	14
Basic Operations	15
Using with Windows	16
Troubleshooting	17
Technical Specifications	18
User Support and Maintenance	19
Warranty Conditions	20

Precautions

Safety Precautions

Please read carefully

This manual is intended to inform you and any other persons who may use this device of possible dangers and safety instructions, in order to help you maximize your enjoyment of this product, and to protect you and your equipment from damage.

- Following is an explanation of symbols used throughout the manual.



This symbol indicates serious warnings about the use of this device. Failure to utilize the device as indicated in the instructions next to this symbol may result in shock, injury, or death.



This symbol indicates dangers associated with the use of this device. Failure to utilize the device as indicated in the instructions with this symbol may result in shock or injury, or may cause damage to the device or host computer system.

- Although this manual should cover all possible situations, if you encounter a problem, or have questions not addressed in the manual, please contact your dealer or our technical support immediately.

Apricorn cannot accept liability for accidents or damage caused through the improper use of this product.



Warning

Never remove the plastic case from this unit. Some components inside operate at high voltages and can cause severe electrical shock if touched.

Make sure that no liquid is spilled or leaks into this unit and that no metal or inflammable objects fall inside since this can cause fire, shock, malfunctioning or accidents.

*** In Case of Accident or Malfunction**

If the unit makes unusual noises or begins smoking, or if a foreign object gets inside the unit, unplug the power cord from the outlet and contact the dealer from which you purchased the unit or a nearby service center.

*** Proper Places for Use and Storage**

- Do not use or store the unit in an excessively hot or cold place.

- Do not use or store the unit in a dusty place or in direct sunlight.

In order to prevent possible failures, do not use or store the unit in a place subject to excessive vibration or in an unstable place.

- Do not place the unit close to a system which generates strong magnetic fields (motor, transformer, television, loudspeaker, magnet, etc.) to prevent malfunction.

- Do not close vents that may cause internal temperature to rise.

- Do not use in an enclosed (unventilated) area.

*** Precautions During Installation**

When connecting this unit to a personal computer or any other equipment, always first turn off the main power of the equipment to be connected.

*** Precautions for Transportation**

- Disconnect cables and remove any PC cards before transporting the unit.

- Use the cardboard box in which the unit was initially packed.

- This is a precision device. Do not subject to excessive shock or vibration.

* **Maintenance of the Plastic Case**

- Do not use thinner, benzene, insecticide, or other volatile substances to clean the case, as this may cause deterioration and delamination of the paint.
- Clean the plastic case and front panel with a soft cloth. Remove severe dirt with a soft cloth moistened with a small amount of neutral detergent diluted with water. Wipe dry after cleaning.
- Disconnect the USB cable from the computer before performing any maintenance on the unit.

CompactFlash Cards

This reader has been tested with the widest variety of CompactFlash cards possible, and is compatible with 3.3v and 5v CompactFlash cards in the following sizes: 2MB, 4MB, 8MB, 16MB, 32MB, 48MB, 64MB, 96MB and 128MB+

Digital Cameras

This CompactFlash card reader supports all **COMPANY** brand cameras. While the card reader is capable of reading and writing cards in a variety of formats (DOS, Macintosh, Windows) CompactFlash cards should always be formatted in the camera to ensure compatibility.

Accessories

Your card reader package includes the following items:

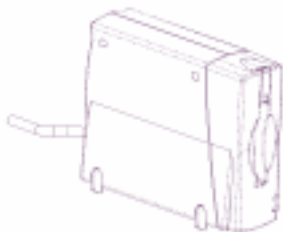

Compact Flash Card Reader (with attached USB connection)

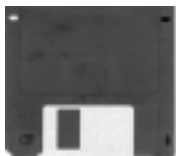

**Floppy disk
with
Drivers for
PC and
User's Manual**

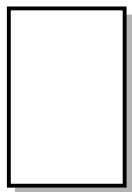

Warranty Card

Parts Identification

USB Compact Flash card reader

Identifying various parts:

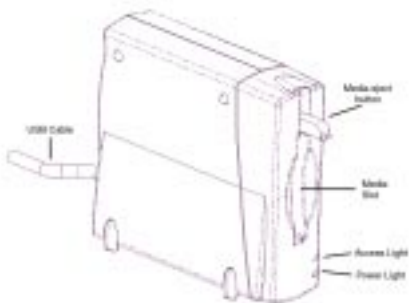

Compatibility with Windows 98, Windows 2000

This card reader requires the following:

1. IBM PC/AT-compatible computer with USB port
2. Windows 98 or Windows 2000

To find your version of Windows software is compatible with USB:

1. Right click on 'My Computer'
2. Click on 'Properties'
3. Click on 'Device Manager'
4. 'Universal Serial Bus controllers' should be listed with a plus sign in front of it. (If you see a flag highlighted in yellow, there is an incompatibility.)

If you do not see this listed, your version of Windows software is not supported, you must upgrade to a more recent version. Microsoft does not offer patches for older Windows versions for USB compatibility with the card reader.

Windows 98 Quickstart Installation Procedure

Follow the guidelines below when installing your card reader.

Before connecting the card reader,
turn on your computer and start Windows.



With the CompactFlash card inserted in the reader, plug the reader
into the USB port or hub.



Install the appropriate device driver.



You may now access your CompactFlash Card reader as a drive
letter. There is no need to reboot your system. Congratulations!

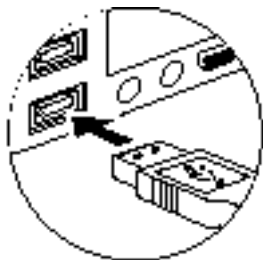

Windows 2000 Quickstart Installation Procedure

Follow the guidelines below when installing your card reader.

Before connecting the card reader,
turn on your computer and start Windows.



With the CompactFlash card inserted in the reader, plug the reader
into the USB port or hub.



The system will automatically install the USB Mass Storage Class Driver.



Reboot your system. You may now access your CompactFlash Card
reader as a drive letter. Congratulations!

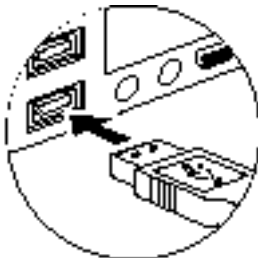

Windows 98 Installation

Before using your CompactFlash card reader for the first time, you must install the device drivers located on the accompanying Floppy.

1. Start Windows on your computer.
2. Connect the IBM CF USB Reader, with a CompactFlash card inserted in the reader, to the USB port or to a powered USB hub.
3. A dialog box with 'New Hardware Found' will appear. Click <Next>
4. Click on Search for the best driver for your device. Click <Next>
5. Insert the Floppy diskette into the Floppy drive.
6. Click on Floppy Disk Drive Box. Click <OK>
7. The wizard will automatically load the driver, Click <Next>.
8. Click <Finished> when the driver is loaded.
9. The Hardware Wizard will automatically run again. Check the Floppy Disk Drive box. Click <OK>. Click <Next>.
10. When the second driver installation is complete, click <Finish>.

You may now access your USB CompactFlash reader as a drive letter. There is no need to reboot your system.

Windows 2000 Installation

Before using your CompactFlash card reader for the first time, you must install the device drivers located on the accompanying CD-ROM.

1. Start Windows on your computer.
2. Connect the IBM CF USB Reader, with a CompactFlash card inserted in the reader, to the USB port or to a powered USB hub.
3. A dialog box with 'New Hardware Found' will appear. The system will automatically install the USB Mass Storage Class driver.
- 4 . The installation is now complete. Reboot you system and then you may access your USB CompactFlash reader as a drive letter.

Connecting the USB CompactFlash Reader to a Computer

Connecting the USB Cable (using without other peripheral devices)

Using the supplied USB cable, connect the card reader to the desired USB port located on the computer. Make sure the cable ends are firmly connected. The Power light will come on when it is properly connected.

CAUTION Be careful not to confuse the upper and lower parts of the connector. Do not force connections, as this may damage the connection or the card reader.

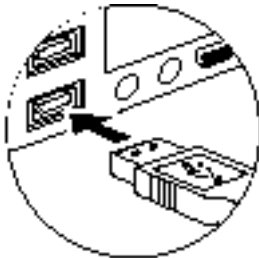

Connecting the USB Cable (using other peripheral devices)

Connect a USB hub (purchased separately) to your computer's USB port. Then connect the card reader to a port on the USB hub. Make sure the connectors are secured firmly. The Power Light will come on when it is properly connected.

Basic Operations

This section explains how to use various types of cards. Before proceeding, make sure device drivers for your reader are installed.

Inserting the Card

Position the card in the direction shown below. Make sure the pin holes face down towards the slot and with the keyed slots on the side of the flash aligned with the correct grooves in the slot. Confirm that the card is inserted firmly.

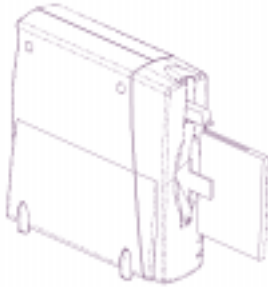

Be careful to insert the card in the proper direction. Inserting a card upside down or forcing it may result in damage to your card reader and consequent loss of data.

Using with Windows

Copying Files

Start Windows double-click the "My Computer" icon to open the "My Computer" window. There, you will see a drive letter icon. (The specific assigned to the drive D, E, and so on will vary, depending on your particular system configuration)

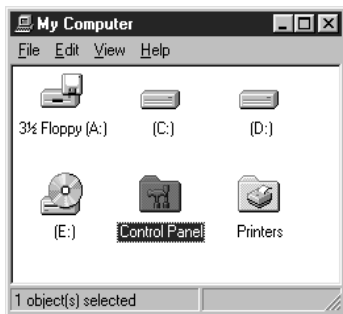

You may now copy files to or from your reader and to or from your hard drive or other connected media types as you would any other media types such as diskettes, harddrives, ect. Drag the icons for the data to be copied and release the mouse button over the destination disk.

Troubleshooting Windows

Symptom	Cause	Corrective Action
The card is not recognized (The "Removable Disk" icon does not appear in the "My Computer" window.)	The Device Drivers have not been properly installed.	Refer to the "Installing the Device Driver" section in this manual, and make sure device drivers are correctly installed.
	The card is not inserted correctly in the card reader.	Check the direction in which the card is inserted and reinsert.
The READY light does not come on.	Windows 98 does not recognize this reader.	<ul style="list-style-type: none">* Check the USB cable connections, making sure they are plugged in properly.* If the reader was connected to a hub, plug it directly into your computer's USB port. Is it recognized?

Technical Specifications

* Specifications are subject to change without notice.

Compatible Cards	CompactFlash cards: 2MB (5V), 4MB (3.3/5V), 8MB (3.3v), 16MB (3.3V), 32MB, 48MB+
Host Interface	USB port (Universal Serial Bus)
Connector of Accessory Cable	Host side USBport (Universal Serial Bus)
Transfer Rate	Up to 800~900KB/s sustained transfer in read mode Up to 470KB/s sustained in write mode
Power Consumption	1.25 watts typical (255mA@5v) no media activity
Dimensions	65 mm (Wide) x 100 mm (Deep) x 18 mm (High)
USB cable	1 metre+ / - 10% shielded twisted pair for signal wires. Input impedance 90 Ohms + / -
Weight (Main unit)	Approximately 101 g
Operational Environment	0-60°C shock 2000 Gs maximum Humidity during use: 5% to 96% (without condensation)

Federal Communications Commission

This equipment has been tested and found to comply with the limits for a Class B digital device, pursuant to Part 15 of the FCC Rules. These limits are designed to provide reasonable protection. This equipment generates, uses and can radiate radio frequency energy, and if not installed and used in accordance with the instructions, may cause harmful interference to radio communications. However, there is no guarantee that interference will not occur in a particular installation. If this equipment does cause harmful interference to radio or television reception, which can be determined by turning the equipment off and on, the user is encouraged to try to correct the interference by one or more of the following measures:

- n Reorient or relocate the receiving antenna.
 - n Increase the separation between the equipment and receiver.
 - n Connect the equipment into an outlet on a circuit different from that to which the receiver is connected.
 - n Consult the dealer or an experienced radio/TV technician for help
- Shielded interface cables must be used in order to comply with emission limits.

Specifications not expressly approved by the party responsible for compliance could void the user's authority to operate the equipment.

User Support and Maintenance

User Support

Questions regarding this product may be answered by contacting user support as indicated below. Please consult the "Troubleshooting" section of this manual before contacting us for assistance.

User Support

Apricorn

12191 Kirkham Rd. Poway, CA 92064

Tel :858-513-2000 or 800-458-5448

Fax: 858-513-2020

email: support@apricorn.com

hours of operation: 8:00a.m. - 5:00p.m. PST

n Please remember to fill in the Registration Card and return it to us. This information is important in assisting us in supporting you, and troubleshooting your reader in case of malfunction.

Maintenance

Before calling for repairs, please follow these important steps.

1. If you must return the unit, call the RMA department at the phone number listed above. Apricorn will not accept C.O.D. charges. This unit is a precision device, and care should be taken to package it properly.

Warranty Conditions

Statement of Warranty: Apricorn warrants a lifetime warranty from the date of purchase that this product 1) is free from defects in materials and workmanship and 2) conforms to its specifications. If this product does not function as warranted during the warranty period, Apricorn, at its option, will either replace this product with one that is functionally equivalent or will refund your purchase price. These are your exclusive remedies under this warranty. Please call 1-800-458-5448 for warranty service.

Made in USA, manufactured, distributed and sold by Apricorn, official licensee for this product. IBM, the IBM logo and IBM trade dress are owned by International Business Machines Corporation and are used under a license from IBM. IBM does not manufacture this product and provides no warranty or support for this product. Please contact Apricorn at 1-800-458-5448 for all questions/comments and service or support related to this product.

This warranty will be voided by misuse, improper physical environment, accident, or improper maintenance by you. THIS WARRANTY REPLACES ALL OTHER WARRANTIES OR CONDITIONS, EXPRESS OR IMPLIED, INCLUDING BUT NOT LIMITED TO, THE IMPLIED WARRANTIES OR CONDITIONS OF MERCHANTABILITY AND FITNESS FOR A PARTICULAR PURPOSE. THESE WARRANTIES GIVE YOU SPECIFIC LEGAL RIGHTS AND YOU MAY ALSO HAVE OTHER RIGHTS WHICH VARY FROM JURISDICTION TO JURISDICTION. SOME JURISDICTIONS DO NOT ALLOW THE EXCLUSION OR LIMITATION OF EXPRESS OR IMPLIED WARRANTIES, SO THE ABOVE EXCLUSION OR LIMITATION MAY NOT APPLY TO YOU. IN THAT EVENT, SUCH WARRANTIES ARE LIMITED IN DURATION TO THE WARRANTY PERIOD. NO WARRANTIES APPLY AFTER THAT PERIOD.

Circumstances may arise where, because of a default on Apricorn part or other liability, you are entitled to recover damages from Apricorn. In each such instance, regardless of the basis on which you are entitled to claim damages from Apricorn (including fundamental breach, negligence, misrepresentation, or other contract or tort claim), Apricorn is only liable for:

1. damages for bodily injury (including death) and damage to real property and tangible personal property; and
2. the amount of any other actual direct damages or loss, up to the greater of \$500 or the price paid for this product.

UNDER NO CIRCUMSTANCES IS APRICORN OR IBM LIABLE FOR ANY OF THE FOLLOWING: (1) THIRD-PARTY CLAIMS AGAINST YOU FOR LOSSES OR DAMAGES (OTHER THAN THOSE UNDER THE FIRST ITEM LISTED ABOVE); (2) LOSS OF, OR DAMAGE TO, YOUR RECORDS OR DATA; OR (3) SPECIAL, INCIDENTAL OR INDIRECT DAMAGES OR FOR ANY ECONOMIC CONSEQUENTIAL DAMAGES (INCLUDING LOST PROFITS OR SAVINGS), EVEN IF Apricorn OR IBM ARE INFORMED OF THEIR POSSIBILITY. SOME JURISDICTIONS DO NOT ALLOW THE EXCLUSION OR LIMITATION OF INCIDENTAL OR CONSEQUENTIAL DAMAGES, SO THE ABOVE EXCLUSION OR LIMITATION MAY NOT APPLY TO YOU.